

NORTEK GLOBAL HVAC, LLC

Owner's Manual
Installation Instructions

Split System Heat Pump



16 SEER Wall Mounted Indoor Unit 30K & 36K

- Please read this owner's manual carefully before operation and retain for future reference.
- Specifications & illustrations subject to change without notice or incurring obligations.

GHH30(8.8)LSK4DL

GXH30(8.8)LSK4DL

GHH36(10.6)LSK4DL

GXH36(10.6)LSK4DL

Contents

Operation Notices

Precautions.	1
Parts Name.	6

Screen Operation Guide

Remote Control Buttons.	7
Display Screen Icons	7
Remote Control Button Description	8
Combination Button Functions	12
Operation Guide	13
Replacing Batteries in Remote.	13

Maintenance

Emergency Operation.	14
Cleaning and Maintenance.	14

Troubleshooting

Troubleshooting	17
---------------------------	----

Installation

Installation Clearances.	20
Tools for Installation	21
Installation Location Selection	21
Electrical Requirements	22
Indoor Unit Installation	23
Outdoor Unit Installation.	28
Vacuum Pumping	31
Leak Detection	31

Testing and Operation

After Installation Checklist	32
Test Operation	32

Connections

Connection Pipe Configuration.	33
Pipe Expansion Method	35

This appliance is not intended for use by persons (including children) with reduced physical, sensory or mental capabilities, or lack of experience and knowledge. Children should not play with the appliance.

Explanation of Symbols

 **DANGER**

Failure to comply will result in severe personal injury, property damage and/or death.

 **WARNING**

Failure to comply may result in severe personal injury, property damage and/or death.

 **CAUTION**

Failure to comply may result in personal injury and/or property damage.

 **NOTICE**

Indicates important but not hazard-related information, used to indicate risk of property damage.



Operation and Maintenance

- This appliance should not be used by children or persons with reduced physical, sensory or mental capabilities or lack of experience and knowledge.
- Children shall not play with the appliance.
- Cleaning and user maintenance shall not be performed by children.
- Do not connect air conditioner to multi-purpose socket. Otherwise, it may cause fire hazard.
- Disconnect power supply when cleaning air conditioner. Otherwise, it may cause electric shock.
- If the supply cord is damaged, it must be replaced by qualified persons.
- Do not wash the air conditioner with water to avoid electric shock.
- Do not spray water on indoor unit. It may cause electric shock or malfunction.
- After removing the filter, do not touch fins to avoid injury.
- Do not dry filter over open flame or with hair dryer to avoid warping fire hazard.
- Maintenance must be performed by qualified professionals. Otherwise, it may cause personal injury or damage.
- Do not repair air conditioner by yourself. It may cause electric shock or damage. Please contact dealer when you need to repair air conditioner.

Precautions



WARNING

- Do not insert fingers or objects into air inlet or air outlet. It may cause personal injury or damage.
- Do not block air outlet or air inlet. It may cause malfunction.
- Do not spill water on the remote controller.
- When below situations occur, please turn off air conditioner and disconnect power immediately, and then contact the dealer or qualified professionals for service.
 - Power cord is overheating or damaged.
 - There's abnormal sound during operation.
 - Circuit breaker trips off frequently.
 - Air conditioner gives off burning smell.
 - Indoor unit is leaking.
- If the air conditioner malfunctions, it may cause electric shock or fire.
- When turning on or turning off the unit by emergency operation switch, please press this switch with an insulating object other than metal.
- Do not place objects on outdoor unit or use as step. It may cause damage or personal injury

Precautions



WARNING

Attachment

- Installation must be performed by qualified professionals. Otherwise, it may cause personal injury or damage.
- Follow all the electric safety regulations when installing the unit.
- Use approved power supply circuit and circuit breaker according to local regulations.
- A circuit breaker must be used.
- An all-pole disconnect switch having a contact separation of at least 3mm (1/8 in) in all poles should be connected in fixed wiring.
- Include a circuit break with suitable capacity, please note the capacity table. Air switch should include magnet buckle and heating buckle function, to protect from circuit-short and overload.
- Air Conditioner should be properly grounded. Incorrect grounding may cause electric shock.
- Use only an approved power cord.
- Make sure the power supply matches the requirement listed on nameplate. Unstable power supply or incorrect wiring may cause malfunction. Please install proper power supply cables before using the air conditioner.
- Properly connect the live wire, neutral wire and grounding wire.
- Be sure to cut off the power supply before performing any work related to electricity.

Precautions



WARNING

- Do not connect power before finishing installation.
- If the supply cord is damaged, it must be replaced by qualified persons.
- The temperature of refrigerant circuit will be high, please keep all cords and cables away from the copper tube.
- The appliance shall be installed in accordance with national wiring regulations.
- Installation must be performed in accordance with the requirement of NEC and CEC by authorized personnel only.
- The air conditioner is Class I electric appliance. It must be properly grounded by a professional, otherwise it may cause electric shock.
- The yellow-green wire in air conditioner must be used for grounding only.
- The grounding resistance should comply with national electric safety regulations.
- The appliance must be positioned so that the plug is accessible.
- All wires of indoor unit and outdoor unit should be connected by a professional.
- Use single wires for all connections. Wires should never be spliced together.
- For the air conditioner with plug, the outlet should be reachable after finishing installation.
- For the air conditioner without plug, a circuit break must be installed in the line.

Precautions



WARNING

- Once installed the air conditioner should not be moved and installed in a different location.
- Select a location which is out of reach for children and far away from animals or plants. If it is unavoidable, please put up a fence for safety purpose.
- The indoor unit should be installed close to the wall

Working Temperature Range

	Indoor Temp. DB/WB °C(°F)	Outdoor Temp. DB/WB °C(°F)
Maximum cooling	26.7/19.4(80/66.9)	46.1/23.9(115/75)
Maximum heating	26.7/-(80/-)	23.9/18.3(75/64.9)

NOTICE:

- The operating temperature range (outdoor temperature) for cooling only unit is -18°C(-0.4°F) ~ 46.1°C(115°F); for heat pump unit is -20°C(-4°F) ~ 46.1°C(115°F).

Parts Name

Indoor Unit

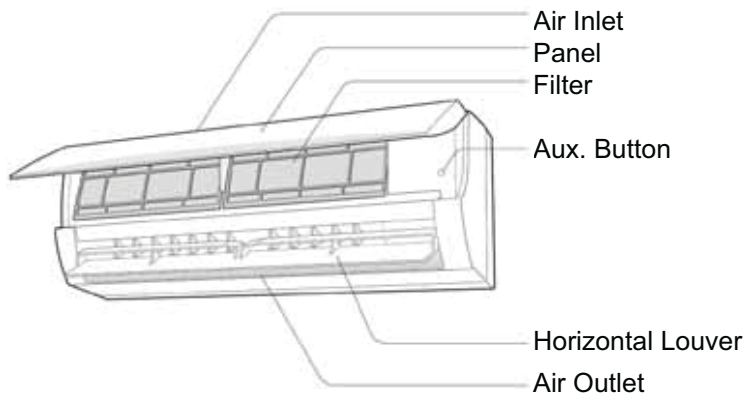

Display

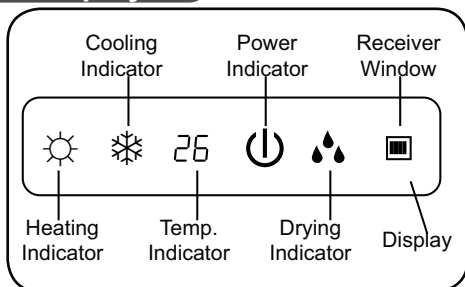

Remote

Outdoor Unit

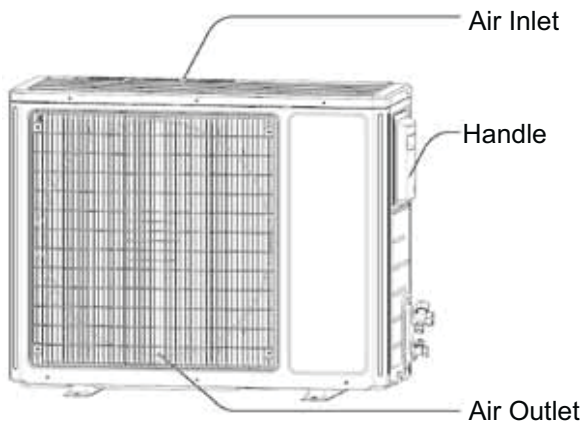

NOTICE:

Illustrations provided apply to different models and are for reference only. Actual equipment may look slightly different.

Remote Control Buttons



1. ON/OFF Button
2. MODE Button
3. + / - Buttons
4. FAN Button
5. (swing) Button
6. CLOCK Button
7. TIMER ON/TIMER OFF Button
8. X-FAN Button
Note: X-FAN is the same as BLOW
9. TEMP Button
10. TURBO Button
11. LIGHT Button
12. SLEEP Button

Display Screen Icons

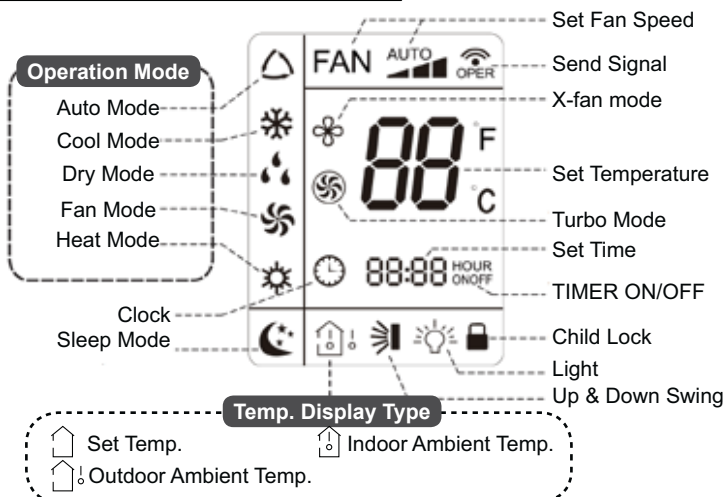

Remote Control Button Description

Note:

- This remote can control different air conditioning models. Some models may not have all functions shown on remote. Pressing the buttons for these functions will have no effect on the air conditioner.
- After turning on the power, the air conditioner will emit a sound. Power indicator  will be ON (red indicator). After that, you can operate the air conditioner by using remote controller.







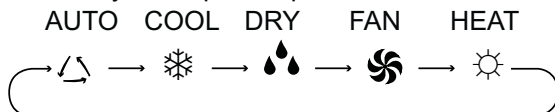

1 ON/OFF Button

Press this button to turn on or turn off the air conditioner. After turning on the air conditioner, operation indicator  on indoor unit's display is ON and indoor unit will give out a sound.

2 MODE Button

Press this button to select your required operation mode.



- When selecting auto mode, air conditioner will operate automatically according to default setting. Set temperature can't be adjusted and will not be displayed. Press "FAN" button to adjust fan speed. Press  button to adjust louver angle.
- After selecting cool mode, air conditioner will operate under cool mode. Cool indicator  on indoor unit is ON. Press + or - button to adjust set temperature. Press "FAN" button to adjust fan speed. Press  button to adjust louver angle.
- When selecting dry mode, the air conditioner operates at low speed under dry mode. Dry indicator  on indoor unit is ON. Under dry mode, fan speed can't be adjusted. Press  button to adjust louver angle.
- When selecting fan mode, only the fan will operate, no cooling and no heating. All indicators are OFF. Press "FAN" button to adjust fan speed. Press  button to adjust louver angle.
- When selecting heating mode, the air conditioner operates under heat mode. Heat indicator  on indoor unit is ON. Press + or - button to adjust set temperature. Press "FAN" button to adjust fan speed. Press  button to adjust louver angle. (Cooling only unit won't react to heating mode signal).

Note:

- For preventing cold air, after starting up heating mode, indoor unit will delay 1~5 minutes to blow air (actual delay time is depend on indoor ambient temperature).
- Set temperature range from remote controller: 16~30°C(61~86°F); Fan speed: auto, low speed, medium speed, high speed.

Remote Control Button Description

3 + / - Button

- Press + or - button once to increase or decrease the temperature 1°C/F. Holding + or - button more than 2 seconds will change the set temperature more quickly. On releasing the button after desired set temperature is reached, the temperature indicator on the indoor unit will change accordingly.
- When setting TIMER ON, TIMER OFF, or CLOCK, press + or - button to adjust time (refer to CLOCK, TIMER ON, TIMER OFF buttons).

4 FAN Button

Press this button to set fan speed: auto (AUTO), low(▲), medium (▲■), high(▲■■■).

Note:

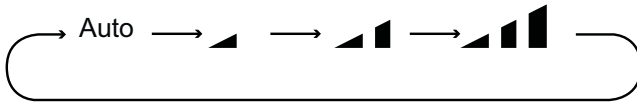

- Under AUTO speed, air conditioner will select proper fan speed automatically based on the ambient temperature.
- Fan speed under dry mode is low speed.

5 SWING Button

Press this button to select up&down swing angle. Louver angle can be selected as shown below:

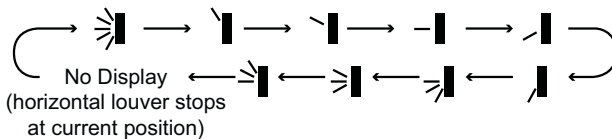

- When selecting the first louver icon, air conditioner is blowing fan automatically. Horizontal louver will automatically swing up & down at maximum angle.
- When selecting the second, third, fourth, fifth, sixth louver icons horizontal louvers will stop at fixed position.
- When selecting the seventh, eighth, ninth louver icons horizontal louver will swing through fixed angles.
- Hold the first louver icon button more than 2s to set your required swing angle. When reaching your required angle, release the button.

Note:

- The seventh, eighth, ninth louver icons may not be available. When air conditioner receives this signal, the air conditioner will default to automatic setting.

Remote Control Button Description

6 Clock Button

- Press this button to set clock time. ☀ icon on remote controller will blink. Press + or - button within 5s to set clock time. Press the of + or - button, once to increase or decrease 1 minute. Hold the + or - button, more than 2 seconds to change time more quickly. Release this button when reaching your required time. Press “CLOCK” button to confirm the time, ☀ icon stops blinking.

Note:

- Clock time defaults to 24-hour mode.
- If no button is pressed for 5 seconds, remote controller will quit setting status. Operation for TIMER ON/TIMER OFF is the same.

7 TIMER ON / TIMER OFF button

• TIMER ON button

“TIMER ON” button can set the time for unit to be turned on. After pressing this button, ☀ icon disappears and the word “ON” on remote controller blinks. Press + or - button to adjust TIMER ON setting. Press the + or - button, once to increase or decrease TIMER ON setting by 1 min. Hold + or - button, for more than 2 seconds to change the time more quickly. Release the button when you reached desired time. Press “TIMER ON” to confirm. The word “ON” will stop blinking. ☀ icon resumes displaying. Cancel TIMER ON: After setting TIMER ON, press the TIMER ON button again to cancel the setting.

• TIMER OFF button

“TIMER OFF” button can set the time for unit to be turned off. After pressing this button, icon disappears and the word “OFF” on remote controller blinks. Press + or - button to adjust TIMER OFF setting. Press the + or - button, once to increase or decrease TIMER OFF setting by 1 min. Hold + or - button, for more than 2 seconds to change the time more quickly. Release the button when you reached desired time.



Press “TIMER OFF” to confirm. “OFF” will stop blinking. ☀ icon resumes displaying. After setting TIMER OFF, press the TIMER PFF button again to cancel the setting.

Note:

- Under on and off status, you can set TIMER OFF or TIMER ON .
- Before setting TIMER ON or TIMER OFF, make sure clock displays current time.
- When TIMER ON or TIMER OFF are set, the ON/OFF button will not work. TIMER ON or TIMER OFF will need to be cancelled as explained above.

Remote Control Button Description

8 X-FAN Button

Press this button under cool and dry mode to start up X-FAN function and  icon on remote controller will be displayed. Press this button again to cancel X-FAN function and  icon will disappear.



Note:

- When X-FAN function is on, if the air conditioner is turned off, indoor fan will continue to run at low speed for a while to help dry any residual water inside the air duct.
- During X-Fan operation, press X-FAN button to turn off X-FAN function. Indoor fan will stop operation immediately.

9 TEMP Button

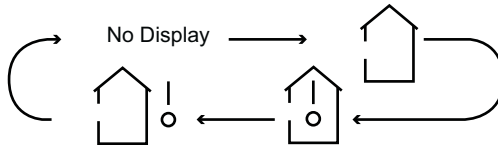
By pressing this button, you can see indoor set temperature, indoor ambient temperature or outdoor ambient temperature on indoor unit's display. As shown below:





- When selecting  or no display with remote controller, temperature indicator on indoor unit displays set temperature.
- When selecting  with remote controller, temperature indicator on indoor unit displays indoor ambient temperature.
- When selecting  with remote controller, temperature indicator on indoor unit displays outdoor ambient temperature.

Note:

- Outdoor temperature display is not available for some models. These models will display the indoor set temperature when outdoor temperature is selected.
- The default setting is the set temperature. The temperature will only be displayed after a set temperature is set up.
- Until set temperature is set up, remote will display "88"
- When selecting indoor or outdoor ambient temperature, indoor temperature indicator displays current temperature and automatically returns to display set temperature after three to five seconds.



5 TURBO Button

Under COOL or HEAT mode, press this button to select quick COOL or HEAT mode.  icon will display on remote controller. Press this button again to exit turbo function and  icon will disappear.



Remote Control Button Description

11 SLEEP Button

Under COOL, HEAT or DRY mode, press this button to start up sleep function.

 icon is displayed on remote controller. Press this button again to cancel sleep function and  icon will disappear.



11 LIGHT Button

Press this button to turn off display light on indoor unit.  icon on remote controller disappears. Press this button again to turn on display light.  icon is displayed.

Combination Button Functions

Child Lock Function

Press + and - buttons simultaneously to turn on or turn off child lock function.

When child lock function is on,  icon is displayed on remote controller. If you press any button on the remote controller, the  icon will blink three times without sending signal to the unit.

Temperature Scale Display Function

Under OFF status, press - and "MODE" buttons simultaneously to switch temperature display between °C and °F.

Operation Guide

1. After turning on the power, press “ON/OFF” button on remote controller to turn on the air conditioner.
2. Press “MODE” button to select your required mode: AUTO, COOL, DRY, FAN, HEAT.
3. Press+ or - button to set your required temperature. (Temperature can't be adjusted under auto mode).
4. Press “FAN” button to set your required fan speed: auto, low, medium and high speed.
5. Press “SWING” button to select fan blowing angle.

Replacing Batteries in Remote

1. Press the back side of remote controller marked “OPEN,” and push the battery cover as shown in the figure to the right.
2. Replace two 7# (AAA 1.5V) dry batteries, and make sure the position of “+” and “-” polar poles are aligned correctly.
3. Reinstall the battery cover.

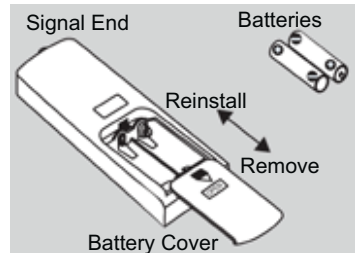

Notice

- During operation, point the remote control signal sender at the receiving window on indoor unit.
- The distance between signal sender and receiving window should be no more than 8m (25 ft), and there should be no obstacles in the path.
- Florescent lamp, wireless telephone or other devices may interfere with the remote signal. If this is the case, move the remote closer to the air conditioner.
- When replacing batteries use the same type of new batteries.
- When you don't use remote controller for a long time, please take out the batteries.
- If the display on remote controller is fuzzy or there's no display, please replace batteries.

Emergency Operation

If remote controller is lost or damaged, please use the auxiliary button for ON/OFF control. Open the panel, press the auxiliary button to turn on or off the air conditioner. When turned on, it will operate under AUTO mode.

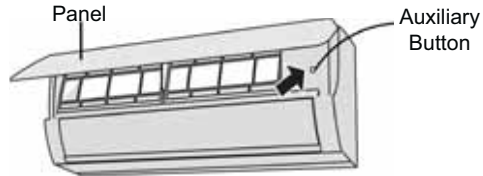

WARNING

Use insulated object to press the auxiliary button.

Cleaning and Maintenance

WARNING

- Turn off the air conditioner and disconnect the power before cleaning to avoid electric shock.
- Do not wash the air conditioner with water to avoid electric shock.
- Do not use volatile liquid to clean the air conditioner.

Cleaning the Surface of Indoor Unit

When the surface of indoor unit is dirty, it is recommended to use a soft dry cloth or damp cloth to wipe it.

NOTICE:

- Do not remove the panel when cleaning it.

Cleaning and Maintenance

Clean Filter

1. Open Panel
Pull out the panel and raise it up as shown below.

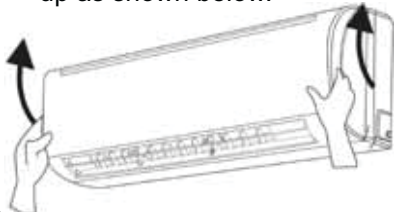

2. Remove Filter
Remove the filter as shown below

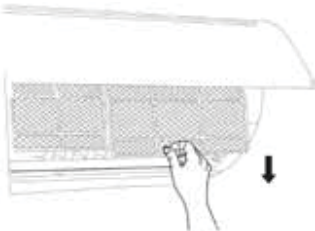

3. Clean Filter
Use dust catcher to clean the filter. If the filter is very dirty, use water. Note: water can not be warmer than 45°C (113°F). Let filter sit in cool dry place until dry.

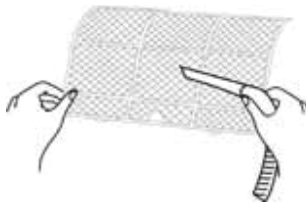

4. Reinstall Filter
Install the filter, and close the panel cover tightly.

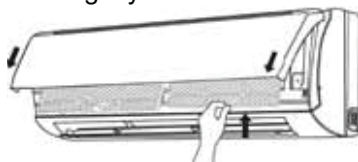

WARNING

- The filter should be cleaned every three months. If air conditioner is exposed to very dusty conditions, please clean the filter more frequently.
- After removing the filter, do not touch fins to avoid personal injury and damage to the unit.
- Never dry filter over open flame or with hair dryer to avoid warping or fire.

Cleaning and Maintenance

Notice: Preseason Checklist

1. Check whether air inlets and air outlets are blocked.
2. Check whether circuit break, plug and socket are in good condition.
3. Check to make sure filter is clean.
4. Check if mounting bracket of outdoor unit is damaged or corroded. If it is, please contact your dealer or qualified service technician.
5. Check if drainage pipe is damaged.

Notice: Post-Season Checklist

1. Disconnect power supply.
2. Clean filter and indoor unit panel.
3. Check if mounting bracket of outdoor unit is damaged or corroded. If it is, please contact your dealer or qualified service technician.

Disposal and Recycling

1. Many packing materials are recyclable. Please dispose or recycle responsibly.
2. Contact local dealer or service center for the proper disposal method.

Troubleshooting

General Analysis

Please check below items before asking for maintenance. If the malfunction persists, please contact a local dealer or other qualified professional.

Malfunction	Check Items	Solutions
Wireless controller won't work	<ul style="list-style-type: none"> The air conditioner may be receiving false signals from other electromagnetic sources. Or, too many signals have been sent too rapidly from the wireless controller 	<ul style="list-style-type: none"> Unplug the air conditioner. Wait 3 minutes and plug it in again. Turn unit back on.
	<ul style="list-style-type: none"> Is the remote controller within the signal receiving range? 	<ul style="list-style-type: none"> Signal receiving range is 8M (25 ft).
	<ul style="list-style-type: none"> Are there obstacles between remote and air conditioner? 	<ul style="list-style-type: none"> Remove obstacles.
	<ul style="list-style-type: none"> Is remote controller pointing at the receiving window? 	<ul style="list-style-type: none"> Select proper angle and point the remote controller at the receiving window on indoor unit.
	<ul style="list-style-type: none"> Is sensitivity of remote controller low; fuzzy display or no display? 	<ul style="list-style-type: none"> Check the batteries. Replace them if needed.
	<ul style="list-style-type: none"> No display when operating remote controller? 	<ul style="list-style-type: none"> Check whether remote controller appears to be damaged. If yes, replace it.
	<ul style="list-style-type: none"> Fluorescent lamp in room? 	<ul style="list-style-type: none"> Move the remote controller closer to indoor unit. Turn off the fluorescent lamp and then try it again.
The indoor unit is on, but will not run	<ul style="list-style-type: none"> Is the air inlet or outlet of the indoor unit blocked? 	<ul style="list-style-type: none"> Eliminate obstacles.
	<ul style="list-style-type: none"> Under heating mode, indoor temperature is reached to set temperature? 	<ul style="list-style-type: none"> After reaching to set temperature, indoor unit will stop.
	<ul style="list-style-type: none"> Was heating mode just turned on? 	<ul style="list-style-type: none"> In order to prevent blowing out cold air, indoor unit waits until heating element has warmed up.

Troubleshooting

Malfunction	Check Items	Solutions
Air conditioner won't run	• Power failure?	• Wait until power recovery.
	• Is plug loose?	• Reinsert the plug.
	• Circuit break trips off or fuse is burnt out?	• Ask professional to replace circuit break or fuse.
	• Wiring malfunction?	• Call professional for repair.
	• Unit has restarted immediately after stopping operation?	• Wait for 3 min, and then turn on the unit again.
	• Is the function setting for remote controller is correct?	• Reset the function.
Mist emitted from indoor unit air outlet	• Is indoor temperature and humidity high?	• Mist is formed when indoor air is humid and cooled rapidly. After air conditioner runs a while, indoor temperature and humidity will decrease and mist will disappear.
Set temperature can't be adjusted	• Is unit operating under auto mode?	• Temperature can't be adjusted under auto mode. Switch the operation mode if you need to adjust temperature.
	• Does the desired temperature exceeds the set temperature range?	• Set temperature range: 16~30°C (61~86°F).
Poor cooling (heating performance)	• Is the supply voltage too low?	• If temporary occurrence, wait until voltage returns to normal. • Contact a qualified electrician.
	• Is the filter dirty?	• Clean filter.
	• Is the set temperature in allowable range?	• Adjust temperature to proper range.
	• Are doors or windows open?	• Close door or window.
Odor emitted	• Is there an odor source in the room such as cigarettes?	• Eliminate source of odor. • Clean filter.
Air conditioner operates erratically	• Is there interference, such as thunder, wireless devices, etc	• Turn unit off. Turn off power supply. Reconnect power after a few seconds. Turn unit back on. If problem persists, contact a qualified service technician.

Troubleshooting

Malfunction	Check Items	Solutions
Water flowing noise	<ul style="list-style-type: none"> • Has air conditioner just been turned on or turned off? 	<ul style="list-style-type: none"> • The noise is the sound of the unit, which is normal.
Cracking noise	<ul style="list-style-type: none"> • Has air conditioner just been turned on or turned off? 	<ul style="list-style-type: none"> • This is the sound of friction caused by expansion and/or contraction of panel or other parts due to the change of temperature.

Error Codes

- When air conditioner malfunctions, the temperature indicator on indoor unit will blink displaying the corresponding error code. Please refer to the below list for required action to be taken.

Error Code	Troubleshooting
C5	Please contact qualified professional for service.
E5	It can be eliminated after restarting the unit. If not, please contact qualified professional for service.
E8	It can be eliminated after restarting the unit. If not, please contact qualified professional for service.
F1	Please contact qualified professional for service.
F2	Please contact qualified professional for service.
H6	It can be eliminated after restarting the unit. If not, please contact qualified professional for service.
U8	It can be eliminated after restarting the unit. If not, please contact qualified professional for service.

Note:

For any other error codes contact qualified professional for service.



WARNING

- When any of the following situations occur, turn off air conditioner, disconnect power immediately, and contact a qualified professional for service.
 - Power cord is overheating or damaged.
 - There's abnormal sound during operation.
 - Air switch trips off frequently.
 - Air conditioner gives off burning smell.
 - Indoor unit is leaking.
- Do not repair or refit the air conditioner by yourself.
- If the air conditioner continues to operate while malfunctioning, it may be damaged beyond repair or cause electrical shock or fire.

Installation Clearances

Dimension below show minimum clearances from obstacles, walls, ceiling, floor, etc. allowed around indoor and outdoor units.

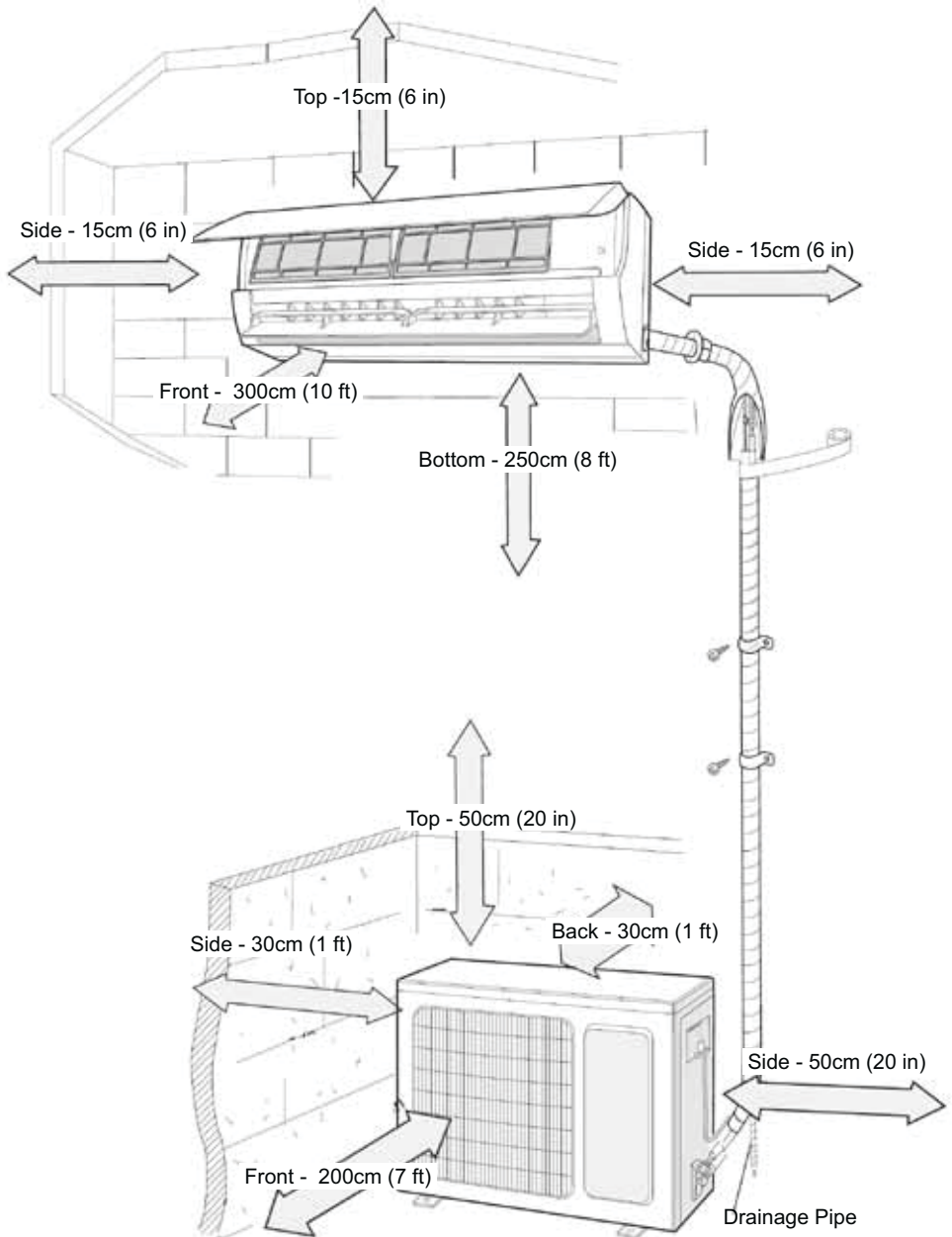

Tools for Installation

- | | | |
|------------------|--------------------|--------------------|
| 1. Level | 6. Torque wrench | 11. Pressure Meter |
| 2. Screwdriver | 7. Open-end wrench | 12. Multi-meter |
| 3. Impact drill | 8. Pipe cutter | 13. Hexagon wrench |
| 4. Drill bit | 9. Leak detector | 14. Measuring tape |
| 5. Pipe expander | 10. Vacuum pump | |

Note:

- Contact qualified professional for installation
- Proper power cord must be used.

Installation Location Selection

Basic requirement:

Installing the unit in the following places may cause malfunction.

1. Places with strong heat sources, vapors, flammable or explosive gasses, or volatile objects spread in the air.
2. Places with high-frequency devices (such as welding machine, medical equipment).
3. Coastal regions.
4. The place with oil or other fumes in the air.
5. Places with high sulfur gas concentration in the air.
6. Other places with special circumstances.
7. Do not use the unit in a laundry, bath, shower, or indoor swimming pool.

Indoor Unit

1. There should be no obstruction near air inlet and air outlet.
2. Select a location where the condensation water can be drained easily and won't drip on people, animals, other's property, etc.
3. Select a location which is convenient to connect the outdoor unit and near the power socket.
4. Select a location which is out of reach for children.
5. The support structure should have sufficient load-carrying capacity to support the weight of the unit. The unit should be securely mounted to avoid vibration.
6. The air conditioner must be installed 2.5m (8 ft) above the floor.
7. Don't install the indoor unit right above an electric appliance.
8. It's best to keep unit as far as possible from fluorescent lamps.

Electrical Requirements

Safety Precautions

1. Follow all electric safety regulations when installing the unit.
2. Use approved power supply, circuit and circuit breaker as required by local regulations.
3. Make sure the power supply matches with the requirement listed on the nameplate. Unstable power supply or incorrect wiring will cause malfunction. Use approved power supply cable.
4. Properly connect the live wire, neutral wire and grounding wire.
5. Turn off the power supply before performing any work related to electricity and safety.
6. Complete all installation requirements before connecting power supply.
7. If the power cord is damaged, it must be replaced by qualified personnel.
8. The refrigerant piping will be hot. Be sure to keep all cables away from copper tubing.
9. The appliance shall be installed in accordance with national wiring regulations.
10. Installation must be performed in accordance with NEC and CEC requirements by authorized personnel only.

Grounding Requirement

1. The air conditioner is a Class I electric appliance. It must be properly grounded with specialized grounding device by a professional, or it may cause electric shock.
2. The yellow-green wire in air conditioner can only be used as the grounding wire.
3. The grounding resistance should comply with national electric safety regulations.
4. The appliance must be positioned so that the plug is accessible.
5. An all-pole disconnection switch having a contact separation of at least 3mm (1/8 in) in all poles should be connected in fixed wiring. For models with a power plug, make sure the outlet is within reach after installation.

Air Conditioner Size	Circuit Breaker Capacity
30K	30A
36K	40A

Indoor Unit Installation

Step one: choosing installation location

Consult with building owner on installation location, then confirm appropriateness before installing.

Step two: install wall-mounting frame

1. Hang the wall-mounting frame on the wall; make sure it is level. Mark the screw locations on the wall.
 2. Drill holes in the wall for screws. Insert plastic expansion or anchor in the hole.
 3. Attach the wall-mounting frame on the wall with tapping screws (ST4.2X25TA) and then check if the frame is firmly installed.
-

Step three: open piping hole

1. Select the location for the outlet pipe and make an opening in the wall. The position of piping hole should be a little lower than the wall-mounted frame, shown as below.

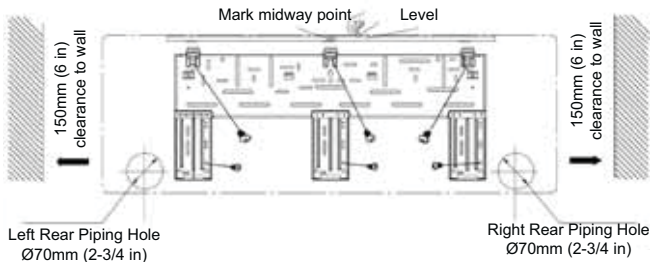

2. Open a piping hole with the diameter of 70mm (2-3/4 in) at the selected position. In order to drain smoothly, slope the piping hole on the wall slightly downward to the outdoor side with the gradient of 5-10°.

Indoor Unit Installation

Note:

- Take all appropriate safety precautions when making pipe hole. Try to avoid creating as much dust as possible.
- The plastic expansion anchors are not provided and should be provided by installing contractor.

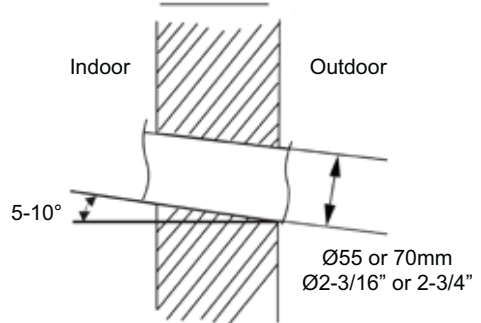

Step four: outlet pipe

1. The pipe can be led out in the right, rear right, left, or rear left of the air conditioner.
2. After selection position of outlet pipe (left or right), cut off the corresponding hole on bottom of case.

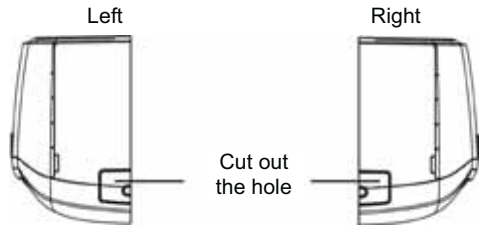
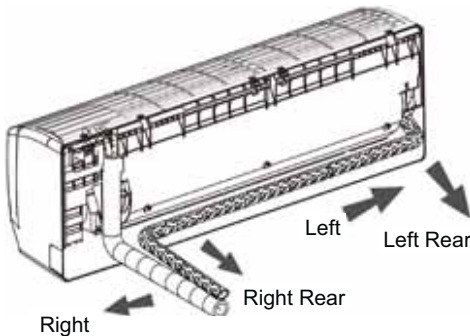

Step five: connect pipe to outdoor unit

1. Align the pipe joint at the corresponding valve.
2. Tighten the union nut by hand.
3. Adjust the torque force by referring to the following sheet. Place the open-end wrench on the pipe joint and place the torque wrench on the union nut. Tighten the union nut with torque wrench.

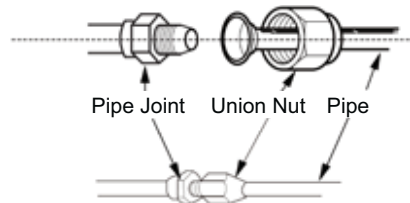

Indoor Unit Installation

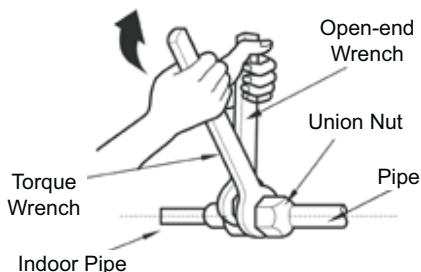

Hex Nut Diameter	Tightening Torque (N·m)
Ø6mm (1/4 in)	15~20
Ø9.52mm (3/8 in)	30~40
Ø 12mm (1/2 in)	45~55
Ø16mm (5/8 in)	60~65
Ø19mm (3/4 in)	70~75

4. Wrap the indoor pipe and joint of connection pipe with insulating pipe, and then wrap it with tape.

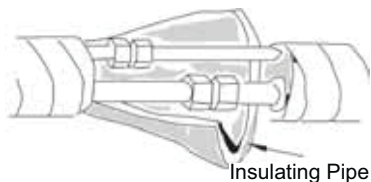

Step six: install drain hose

1. Connect the drain hose to the outlet pipe of indoor unit.
2. Secure the joint with tape.

Note:

- Add insulating pipe in the indoor drain hose in order to prevent condensation.
- The plastic expansion anchors are not provided.

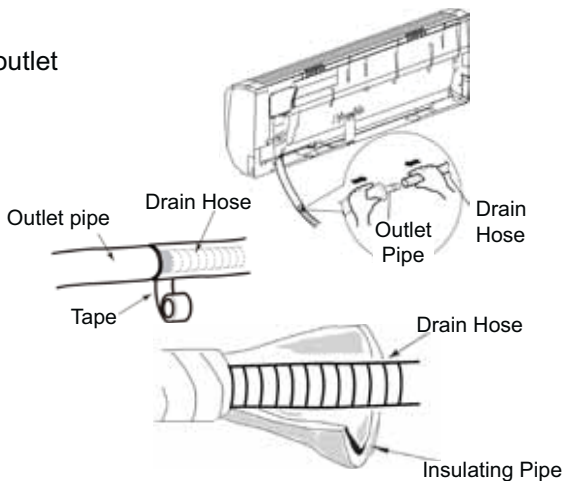

Step seven: connect wire of indoor unit

1. Open the panel, remove the screw on the wiring cover and then take down the cover.

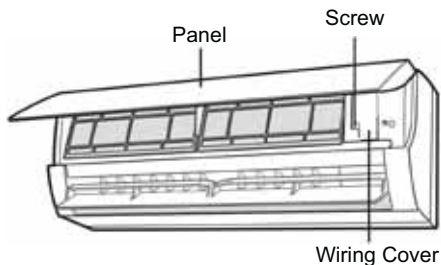

Indoor Unit Installation

2. Lead the power wire through the cable-cross hole at the back of indoor unit and then pull it out from the front side.
3. Remove the wire clip; connect the power connection wire to the wiring terminal according to the color. Tighten the screw and secure the power cable with the wire clip.

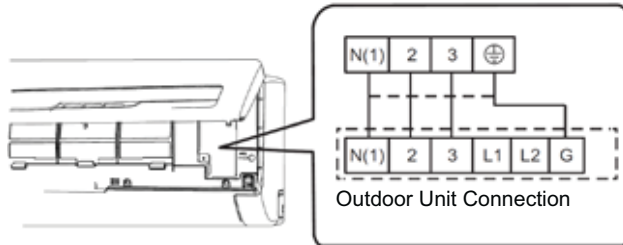
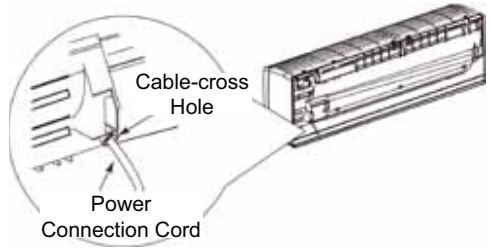

4. Replace wiring cover and tighten the screw.
5. Close the panel.

Note:

- All wires of indoor unit and outdoor unit should be connected by a professional.
- Only single unbroken electrical wires should be used. Spliced wires are not allowed.
- For air conditioner models with electrical plug, the outlet must be reachable after finishing installation.
- For air conditioner models without plug, a circuit breaker must be installed in the line. The circuit breaker should be all-pole parting and the contact parting distance should be more than 3mm (1/8 in).

Indoor Unit Installation

Step eight: bind up pipe

1. Bind the connection pipe, power cord and drain hose with tape.

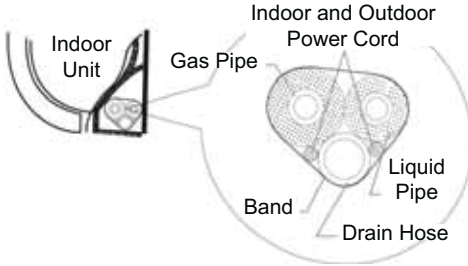

2. Reserve a certain length of drain hose and power cord for installation when binding them. When binding to a certain degree, separate the indoor power and then separate the drain hose.

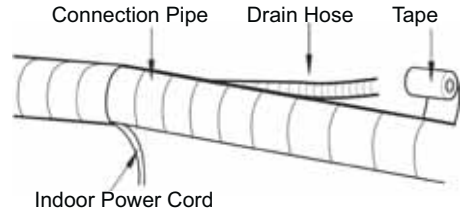

3. Bind them evenly.
4. The liquid pipe and gas pipe should be bound separately at the end.

Note:

- The power cord and control wire can't be crossed or winding.
- The drain hose should be bound at the bottom.

Step nine: hang the indoor unit

1. Put the bound pipes in the wall pipe and lead through the wall hole.
2. Hang the indoor unit on the wall-mounting frame.
3. Fill the gap between pipes and wall hole with sealer to prevent drafts.
4. Secure the wall pipe.
5. Check that the indoor unit is securely installed against the wall.

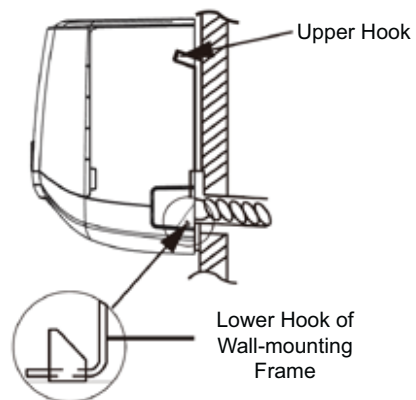
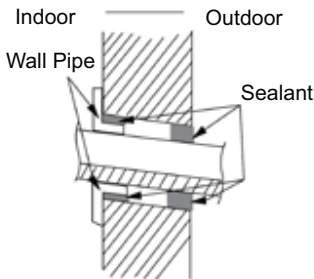

Note:

- Keep bends in drain line to a minimum number and degree to prevent blockage.

Outdoor Unit Installation

Step one: secure the support structure (select it based on installation needs)

1. Select installation location based on building construction and surroundings.
2. Secure the support of outdoor unit on the selected location with expansion screws.

Note:

- Take sufficient protective measures when installing the outdoor unit.
- Make sure the support can withstand at least four times of the unit weight.
- The outdoor unit should be installed at least 3cm (1-1/4 in) above the floor in order to install drain.
- For unit with cooling capacity of 2300W~5000W, 6 expansion screws are needed; for unit with cooling capacity of 6000W~8000W, 8 expansion screws are needed; for unit with cooling capacity of 10000W~16000W, 10 expansion screws are needed.

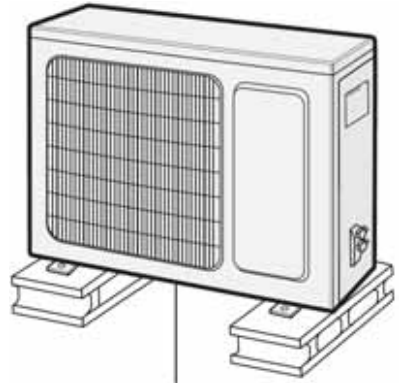

at least 3cm above the floor

Step two: install drain joint (Only for cooling and heating unit)

1. Connect the outdoor drain joint into the hole on the chassis, as shown in the picture below.
2. Connect the drain hose into the drain vent.

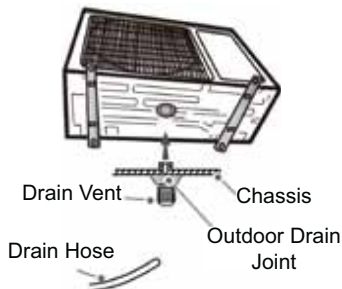

Step three: secure outdoor unit

1. Place the outdoor unit on the support.
2. Fasten the foot holes of outdoor unit with bolts.

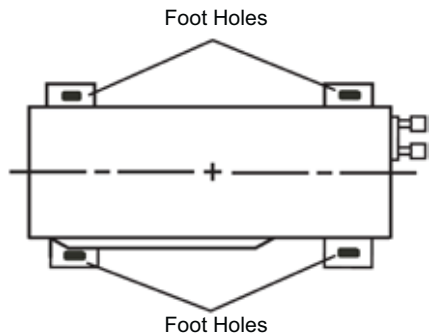

Outdoor Unit Installation

Step four: connect indoor and outdoor pipes

1. Remove the screw on the right handle of outdoor unit and then remove the handle.



2. Remove the screw cap of the valve and align the pipe joint with the pipe bellmouth.

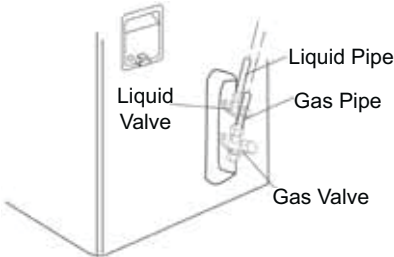

3. Tighten the union nut by hand.

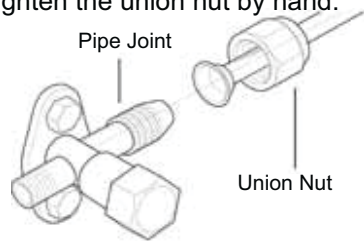

4. Tighten the union nut with torque wrench by referring to the sheet below.

Hex Nut Diameter	Tightening Torque (N-m)
Ø6mm (1/4 in)	15~20
Ø9.52mm (3/8 in)	30~40
Ø 12mm (1/2 in)	45~55
Ø16mm (5/8 in)	60~65
Ø19mm (3/4 in)	70~75

Step five: connect outdoor electric wire

1. Remove the wire clip. Connect the signal connection cord and power cord to the wiring terminal according to color. Attach with screws.

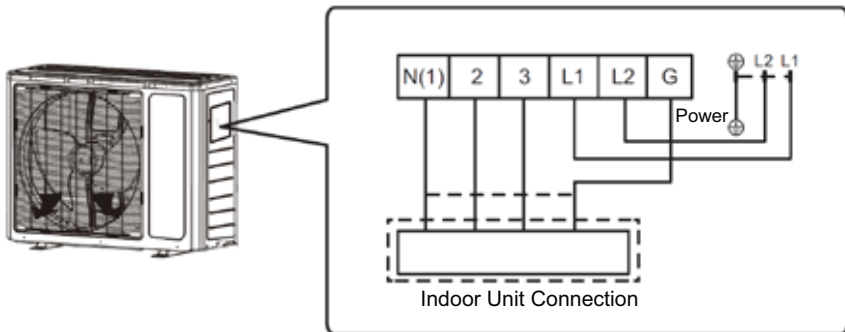

Outdoor Unit Installation

- Secure the power connection wire and signal control wire with the wire clip (for cooling and heating unit only).

Note:

- After tightening the screw, pull on the power cord lightly to check if it is secure.
- Power cord should be a single wire. Splices are not allowed.

Step six: Arrange the pipes

- The pipes should be placed neatly, or hidden, along the wall, with as few bends as possible. Min. radius of pipe bends should be 10 cm (4 in).
- If the outdoor unit is higher than the wall hole, you must make a U-shaped curve in the pipe before pipe goes into the room, to prevent rain from getting inside.

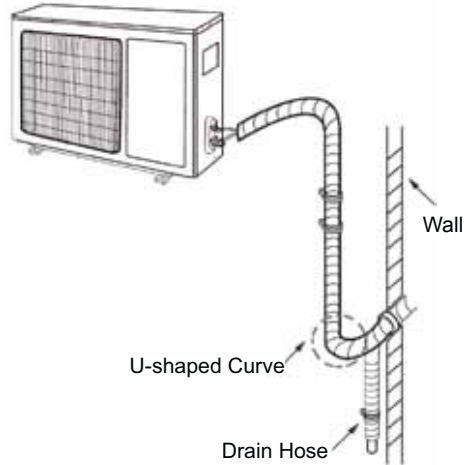

Note:

- The wall hole should be lower than the drain pipe connection on the indoor unit.
- Slope the drain hose slightly downwards with no trapping.

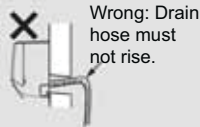

- The water hole must not be placed in water for proper draining.

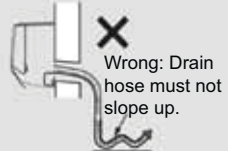
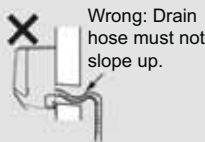
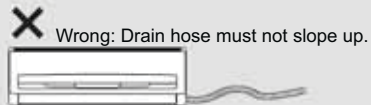
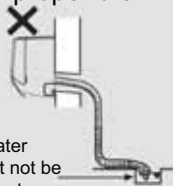

Vacuum Pumping

1. Remove the valve caps on the liquid valve and gas valve and the nut of refrigerant charging vent.
2. Connect the charging hose refrigerant charging of manifold gauge to the refrigerant charging vent of gas nut of refrigerant valve and then connect the other charging hose to the vacuum pump.
3. Open the manifold gauge completely and operate for 10-15 min to check if the pressure of manifold gauge remains at -0.1MPa .
4. Close the vacuum pump and maintain this status for 1-2 min to check if the pressure of manifold gauge remains at -0.1MPa . If the pressure decreases, there may be leakage.
5. Remove the manifold gauge, open the valve core of liquid valve and gas valve completely with hexagon wrench.
6. Tighten the screw caps of valves and refrigerant charging vent.
7. Reinstall the handle.

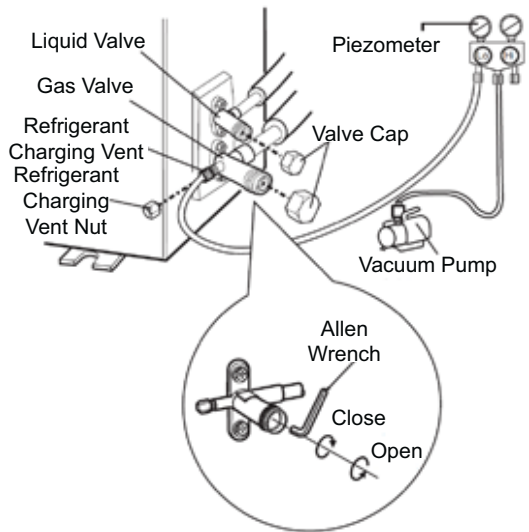

Leak Detection

1. With leakage detector:
Check if there is leakage with leakage detector.
2. With soapy water:
If leakage detector is not available, please use soapy water for leakage detection. Apply soapy water at the suspected leak location and keep it there for more than 3min. If you see air bubbles, there is a leak.

After Installation Checklist

- Check according to the following requirement after completing installation.

Items to check	Possible result
Has the unit been installed securely ?	The unit may fall, shake or emit noise.
Have you done the refrigerant leakage test?	It may cause insufficient cooling (heating) capacity.
Is heat insulation of pipeline sufficient?	It may cause condensation and water dripping.
Will water easily drain?	It may cause condensation and water dripping.
Does the voltage match voltage marked on the nameplate?	It may cause malfunction or damage.
Is electric wiring and pipeline installed correctly?	It may cause malfunction or damage.
Is the unit grounded securely?	It may cause short circuit.
Does the power cord match the specification?	It may cause malfunction or damage
Is there any obstruction in the air inlet and outlet?	It may cause insufficient cooling (heating) capacity.
Is the dust and debris from installation removed?	It may cause malfunction or damage
Are the gas valve and liquid valve of connection pipe open completely?	It may cause insufficient cooling (heating) capacity.
Is the inlet and outlet of piping hole covered?	It may cause insufficient cooling (heating) capacity or drafts.

Test Operation

1. Before testing operation
 - The client approves the installation.
 - Explain operation and other important notes to client.
2. Testing method
 - Turn on the power, press ON/OFF button on the remote controller to start operation.
 - Press MODE button to select AUTO, COOL, DRY, FAN and HEAT to check whether the operation is normal or not.
 - If the ambient temperature is lower than 16°C (61°F), the air conditioner can't start cooling

Connection Pipe Configuration

1. Standard length of connection pipe
 - 5m (16 ft), 7.5m (25 ft), 8m (26 ft).
2. Min. length of connection pipe is 3m (10 ft).
3. Maximum length of connection pipe and maximum height difference.

Cooling Capacity	Max length of connection pipe	Max height difference
5000Btu/h (1465W)	15M (50 ft)	5M (16 ft)
7000Btu/h (2051W)	15M (50 ft)	5M (16 ft)
9000Btu/h (2637W)	15M (50 ft)	5M (16 ft)
12000Btu/h (3516W)	20M (65 ft)	10M (33 ft)
18000Btu/h (5274W)	20M (65 ft)	10M (33 ft)

Cooling Capacity	Max length of connection pipe	Max height difference
24000Btu/h (7032W)	25M (65 ft)	10M (33 ft)
28000Btu/h (8204W)	30M (100 ft)	10M (33 ft)
36000Btu/h (10548W)	30M (100 ft)	20M (65 ft)
42000Btu/h (12306W)	30M (100 ft)	20M (65 ft)
48000Btu/h (14064W)	30M (100 ft)	20M (65 ft)

4. The additional refrigerant oil and refrigerant charging required after extending connection pipe
 - After the length of connection pipe is extended for 10m (33 ft) at the basis of standard length, you should add 5ml (3/16 oz) of refrigerant oil for each additional 5m (16 ft) of connection pipe.
 - The calculation method of additional refrigerant amount (on the basis of liquid pipe):
 - Additional refrigerant amount = additional length of liquid pipe × additional refrigerant charging amount per foot.
 - Basing on the length of standard pipe, add refrigerant according to the requirement as shown in the table. The additional refrigerant charging amount per foot is different according to the diameter of liquid pipe. See the following table.

Connection Pipe Configuration

Additional refrigerant charging amount for R410A.

Diameter of connection pipe mm (in)		Outdoor unit throttle g/m (oz/ft)	
Liquid Pipe	Gas Pipe	Cooling Only	Cooling & Heating
Ø 6 (1/4)	Ø 9.52 or 12 (3/8 or 1/2)	15 (1/6)	20 (1/5)
Ø 6 or 9.52 (3/8 or 1/2)	Ø 16 or 19 (5/8 or 3/4)	15 (1/6)	50 (1/2)
Ø 12 (1/2)	Ø 19 or 22.2 (3/4 or 7/8)	30 (1/3)	120 (1-1/3)
Ø 16 (5/8)	Ø 25.4 or 31.8 (1 or 1-1/4)	60(2/3)	120 (1-1/3)
Ø 19 (3/4)	-	250 (2-2/3)	250 (2-2/3)
Ø 22.2 (7/8)	-	350 (3-3/4)	350 (3-3/4)

Pipe Expansion Method

Note:

Improper pipe expanding is the main cause of refrigerant leakage. Please expand the pipe according to the following steps:

A. Cut the pipe

- Confirm the distance between the indoor and outdoor units.
- Cut the required length with pipe cutter.

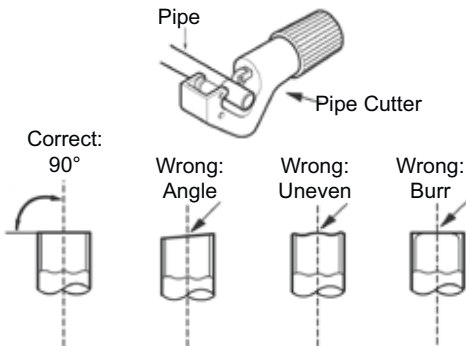

B. Remove the burrs

- Remove the burrs with deburring tool and prevent the burrs from getting into the pipe.

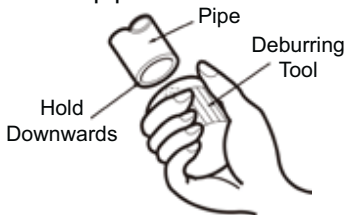

C. Put on suitable insulating pipe

D. Put on the union nut

- Remove the union nut on the indoor connection pipe and outdoor valve; install the union nut on the pipe.

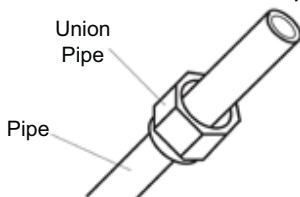

E. Expand the port

- Expand the port with expander.

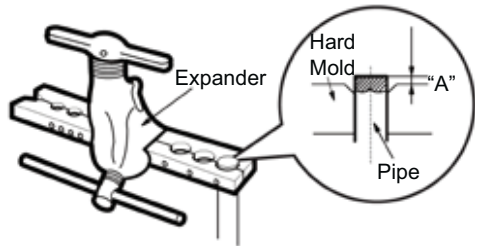

Note:

- "A" is different according to the diameter, please refer to the table below:

Outer diameter mm (in)	A mm (in)	
	Max	Min
Ø6~6.35 (1/4)	1.3 (1/16)	0.7 (1/32)
Ø9.52 (3/8)	1.6 (1/16)	1.0 (1/16)
Ø12~12.7 (1/2)	1.8 (1/16)	1.0 (1/16)
Ø15.8~16 (5/8)	2.4 (3/32)	2.2 (3/32)

F. Inspection

- Check the quality of expanding port. If there is any blemish, expand the port again according to the steps above.

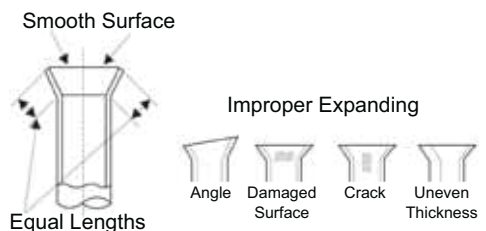

Specifications & illustrations subject to change without notice or incurring obligations.
O'Fallon, MO (05/16) © Nortek Global HVAC, LLC 2016. All Rights Reserved. 580E-0516



66129920531