

REPLACEMENT PARTS LIST

RESIDENTIAL SPLIT SYSTEM AIR CONDITIONER

FSA1BF4M2SN SERIES

16 SEER MODELS



Corner Post Style

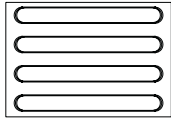

Panel Style

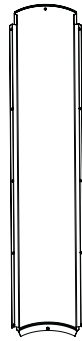
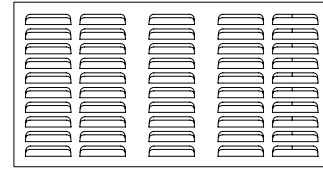

Corner Post

Outdoor Fan Grille

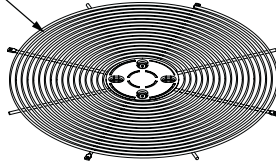

Outdoor Fan Motor

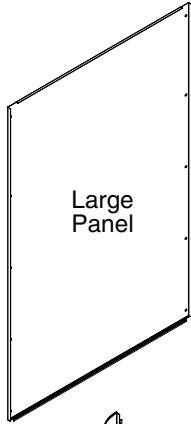
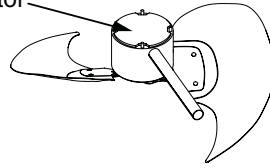

Large Panel

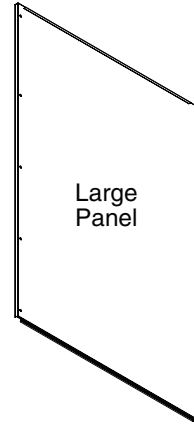

Large Panel

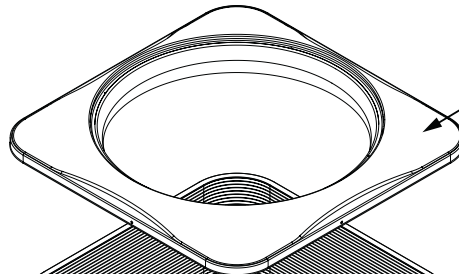

Top Pan

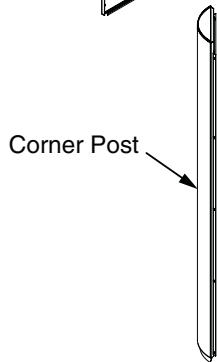

Corner Post



Corner Post

Capacitor

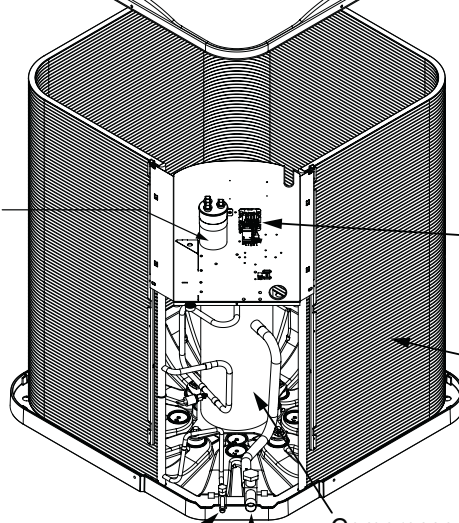

Contactor

Outdoor Coil

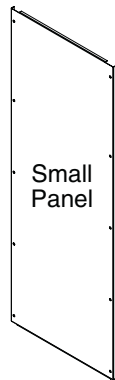

Small Panel

Refrigerant Valve (SM)

Compressor

Refrigerant Valve (LG)

Left Back Post

Right Back Post

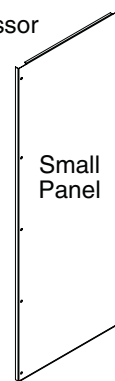

Small Panel

FSA1BF4M2SN SPLIT SYSTEM AIR CONDITIONER WITH MICROCHANNEL

COMPONENT	FSA1BF4M2SN24K	FSA1BF4M2SN36K	FSA1BF4M2SN48K	FSA1BF4M2SN60K
	1014230F	1014231F	1014232F	1014233F
CAPACITOR	01-0083	01-0269	01-0262	01-0084
COMPRESSOR	921844	921769	921659	921793
COMPRESSOR MOLDED PLUG	634660R	634660R	634660R	634660R
COMPRESSOR PLUG, LV 2 STAGE	634661R	634661R	634661R	634661R
CONTACTOR	624826R	624826R	624827R	624828R
CORNER POST	101472304R	101472304R	101472305R	101472306R
CRANKCASE HEATER	632410R	632410R	632410R	632410R
FILTER DRIER	669764R	669764R	669764R	669764R
HIGH PRESSURE SWITCH	632473R	632473R	632473R	632473R
LARGE PANELS	101380304R	101074204R	101074205R	101074206R
LEFT BACK POST	101450404R	101450404R	101450405R	101450406R
LOW PRESSURE SWITCH	632393R	632393R	632393R	632393R
OUTDOOR COIL	1009901R	1009905R	1009904R	1009908R
OUTDOOR FAN BLADE	667345R	667351R	667319R	667319R
OUTDOOR FAN GRILLE	669592R	669591R	669591R	669591R
OUTDOOR FAN MOTOR	621919R	622018R	622656R	622656R
REFRIGERANT VALVE (LG)	663864R	663864R	663865R	663865R
REFRIGERANT VALVE (SM)	663862R	663862R	663862R	663862R
RIGHT BACK POST	101450304R	101450304R	101450305R	101450306R
SMALL PANELS	101380404R	101074404R	101074405R	101074406R
TOP CAP	275291	275291	275291	275291
TOP PAN	101472501R	101472101R	101472101R	101472101R

Please specify the correct Model No., Serial No., and part number(s) when ordering parts from the nearest authorized dealer or service center.



D307336A
(Replaces D3073360)